

Zubehör Positionsgeber für Drehgeber RI-QR24 P1-RI-QR24

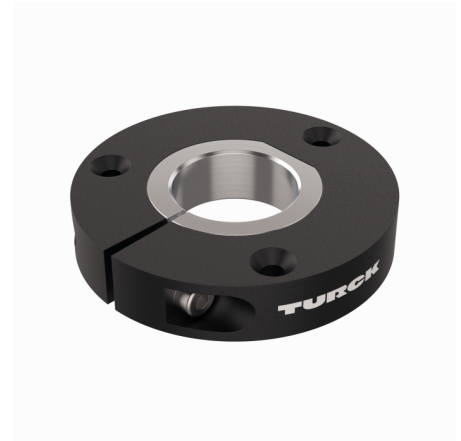
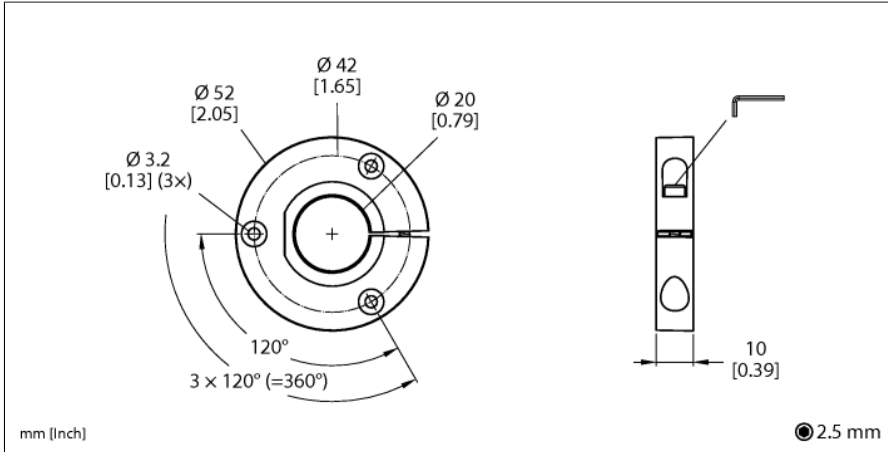

- Positionsgeber zur Anbindung auf Wellen mit 20mm Durchmesser

Typ	P1-RI-QR24
Ident-No.	1590921
Gehäusewerkstoff	Metall/Kunststoff

Zubehör

Typ	Ident-Nr.		Maßbild
P2-RI-QR24	1590922	Positionsgeber zur Anbindung auf \varnothing 14 mm Wellen	<p>Technical drawing of the P2-RI-QR24 position sensor. The front view shows a circular face with a central hole and two smaller holes. Dimensions include $\varnothing 12$ (D.60), $\varnothing 14$ (D.61), $\varnothing 14$ (D.55), $\varnothing 1.2$ (D.11), $\varnothing 1.2$ (D.11), 1.07, and 3×1.07 (H.207). The side view shows a cylindrical body with a diameter of $\varnothing 14$ and a length of 10 (D.56). A note indicates a length of $\bullet 12$ mm.</p>
P3-RI-QR24	1590923	Positionsgeber zur Anbindung auf \varnothing 12 mm Wellen	<p>Technical drawing of the P3-RI-QR24 position sensor. The front view shows a circular face with a central hole and two smaller holes. Dimensions include $\varnothing 12$ (D.60), $\varnothing 12$ (D.55), $\varnothing 1.2$ (D.11), $\varnothing 1.2$ (D.11), 1.07, and 3×1.07 (H.207). The side view shows a cylindrical body with a diameter of $\varnothing 12$ and a length of 10 (D.56). A note indicates a length of $\bullet 12$ mm.</p>
P4-RI-QR24	1590924	Positionsgeber zur Anbindung auf \varnothing 10 mm Wellen	<p>Technical drawing of the P4-RI-QR24 position sensor. The front view shows a circular face with a central hole and two smaller holes. Dimensions include $\varnothing 12$ (D.60), $\varnothing 10$ (D.55), $\varnothing 1.2$ (D.11), $\varnothing 1.2$ (D.11), 1.07, and 3×1.07 (H.207). The side view shows a cylindrical body with a diameter of $\varnothing 10$ and a length of 10 (D.56). A note indicates a length of $\bullet 12$ mm.</p>
P5-RI-QR24	1590925	Positionsgeber zur Anbindung auf \varnothing 6 mm Wellen	<p>Technical drawing of the P5-RI-QR24 position sensor. The front view shows a circular face with a central hole and two smaller holes. Dimensions include $\varnothing 12$ (D.60), $\varnothing 6$ (D.55), $\varnothing 1.2$ (D.11), $\varnothing 1.2$ (D.11), 1.07, and 3×1.07 (H.207). The side view shows a cylindrical body with a diameter of $\varnothing 6$ and a length of 10 (D.56). A note indicates a length of $\bullet 12$ mm.</p>
P6-RI-QR24	1590926	Positionsgeber zur Anbindung auf \varnothing 3/8" Wellen	<p>Technical drawing of the P6-RI-QR24 position sensor. The front view shows a circular face with a central hole and two smaller holes. Dimensions include $\varnothing 12$ (D.60), $\varnothing 9.52$ (D.55), $\varnothing 1.2$ (D.11), $\varnothing 1.2$ (D.11), 1.07, and 3×1.07 (H.207). The side view shows a cylindrical body with a diameter of $\varnothing 9.52$ and a length of 10 (D.56). A note indicates a length of $\bullet 12$ mm.</p>
P7-RI-QR24	1590927	Positionsgeber zur Anbindung auf \varnothing 1/4" Wellen	<p>Technical drawing of the P7-RI-QR24 position sensor. The front view shows a circular face with a central hole and two smaller holes. Dimensions include $\varnothing 12$ (D.60), $\varnothing 6.35$ (D.55), $\varnothing 1.2$ (D.11), $\varnothing 1.2$ (D.11), 1.07, and 3×1.07 (H.207). The side view shows a cylindrical body with a diameter of $\varnothing 6.35$ and a length of 10 (D.56). A note indicates a length of $\bullet 12$ mm.</p>

Zubehör

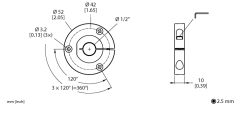
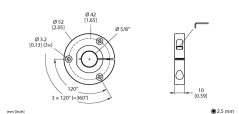
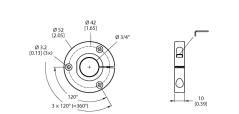
Typ	Ident-Nr.		Maßbild
P9-RI-QR24	1593012	Positionsgeber zur Anbindung auf $\varnothing 1/2''$ Wellen	
P10-RI-QR24	1593013	Positionsgeber zur Anbindung auf $\varnothing 5/8''$ Wellen	
P11-RI-QR24	1593014	Positionsgeber zur Anbindung auf $\varnothing 3/4''$ Wellen	

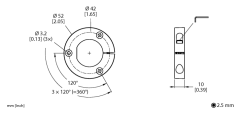
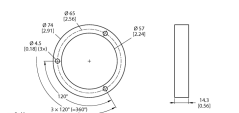

Funktionszubehör

Typ	Ident-Nr.		Maßbild
P8-RI-QR24	1590916	Positionsgeber zur Befestigung auf großen Wellen	
M1-QR24	1590920	Aluminium-Schutzring für induktive Drehgeber RI-QR24	

Funktionszubehör

Typ	Ident-Nr.		Maßbild
PE1-QR24	1590937	Positionsgeber ohne Reduzierhülse	
RA1-QR24	1590928	Reduzierhülse zur Anbindung auf Ø 20 mm Wellen	
RA2-QR24	1590929	Reduzierhülse zur Anbindung auf Ø 14 mm Wellen	
RA3-QR24	1590930	Reduzierhülse zur Anbindung auf Ø 12 mm Wellen	
RA4-QR24	1590931	Reduzierhülse zur Anbindung auf Ø 10 mm Wellen	
RA5-QR24	1590932	Reduzierhülse zur Anbindung auf Ø 6 mm Wellen	

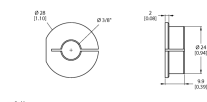
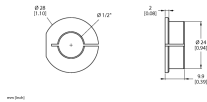
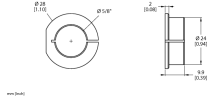
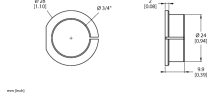
Funktionszubehör

Typ	Ident-Nr.		Maßbild
RA6-QR24	1590933	Reduzierhülse zur Anbindung auf \varnothing 3/8" Wellen	
RA7-QR24	1590934	Reduzierhülse zur Anbindung auf \varnothing 1/4" Wellen	
RA9-QR24	1590960	Reduzierhülse zur Anbindung auf \varnothing 1/2" Wellen	
RA10-QR24	1590961	Reduzierhülse zur Anbindung auf \varnothing 5/8" Wellen	
RA11-QR24	1590962	Reduzierhülse zur Anbindung auf \varnothing 3/4" Wellen	
RA8-QR24	1590959	Stopfen für Montageart C	

Funktionszubehör

Typ	Ident-Nr.		Maßbild
SP1-QR24	1590938	Abschirmplatte Ø 74 mm, Aluminium	
SP2-QR24	1590939	Abschirmplatte Ø 74 mm mit Bohrung für Wellendurchführung, Aluminium	
SP3-QR24	1590958	Abschirmplatte Ø 52 mm, Aluminium	
MT-QR24	1590935	Montagehilfe zur optimalen Ausrichtung des Positionsgebers	